

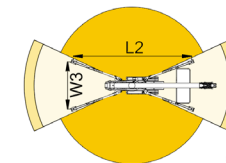

BI-ENERGY

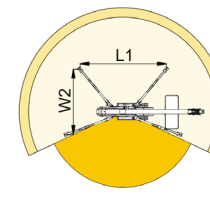
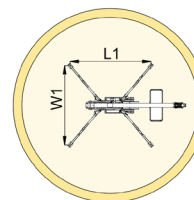
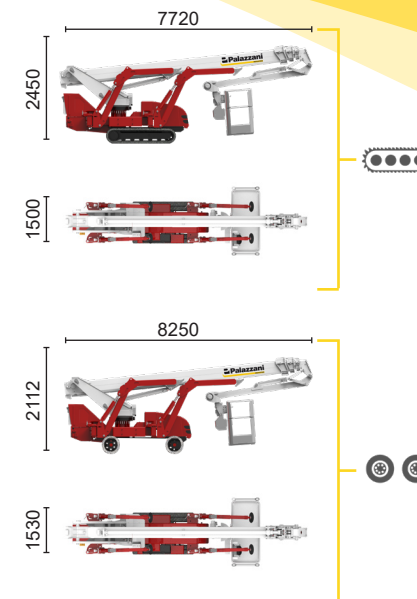
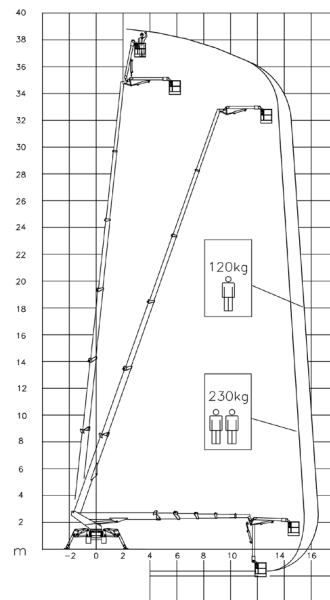
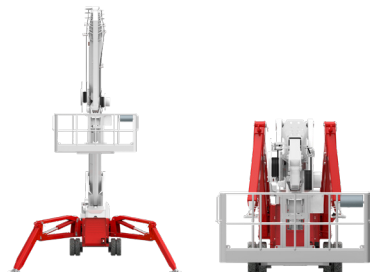

 Diesel
18,2 kW

 Single-phase
Electric motor
230VAC - 2,2 kW



15,5 m	16,5 m	10 m	L1	L2	W1	W2	W3
230 kg	120 kg	230/120 kg	4960 mm	6200 mm	4700 mm	3810 mm	2920 mm



TSJ 39/C		39 m	16,5 m	230 kg	660°	240x70 cm	90°+80°	2,92-4,7 m	18%	40%	1,8 km/h	7960 kg	47 kN	3,41 kN/m ²	4,3 kN/m ²
TSJ 39/R		39 m	14,9 m	230 kg	660°	240x70 cm	90°+80°	2,92-4,7 m	31%	12%	1,4 km/h	7800 kg	47 kN	3,35 kN/m ²	3,94 kN/m ²

Available power options:

BI-ENERGY (DIESEL+AC)

ECO (AC+BATTERY)

HYBRID (DIESEL+AC+BATTERY)

Characteristics and technical data are informative only and subjected to change without notice.

Palazzani Industrie S.p.A.

Via del Pavione, 4 - 25050 - Paderno F.C. (BS) - Italy

Tel. (+39) 0306857073

info@palazzani.it

www.palazzani.it



NC 812 A 22



ECO



Single-phase
Electric motor
230VAC - 16 kW



Lithium iron
phosphate battery
LiFePO4
48V - 315 Ah

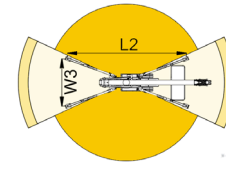
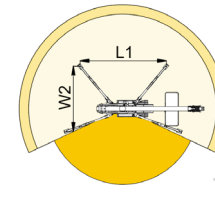
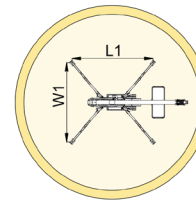
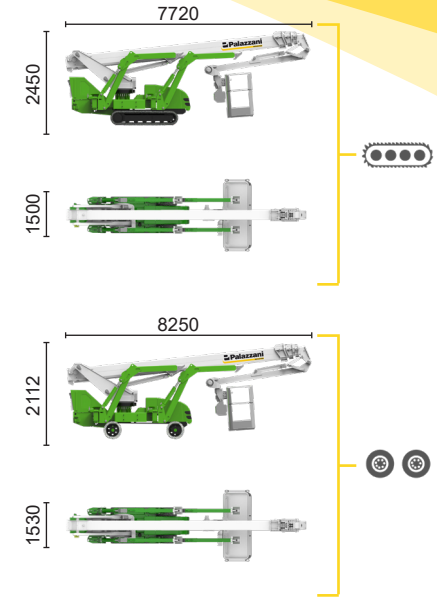
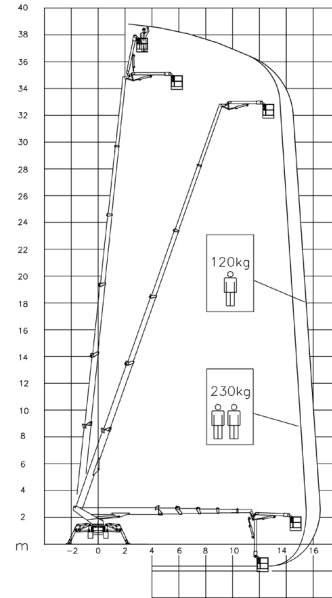

15,5 m	16,5 m	10 m	L1	L2	W1	W2	W3
230 kg	120 kg	230/120 kg	4960 mm	6200 mm	4700 mm	3810 mm	2920 mm



TSJ 39/C		39 m	16,5 m	230 kg	660°	240x70 cm	90°+80°	2,92-4,7 m	18%	40%	1,8 km/h	7960 kg	47 kN	3,41 kN/m ²	4,3 kN/m ²
TSJ 39/R		39 m	14,9 m	230 kg	660°	240x70 cm	90°+80°	2,92-4,7 m	31%	12%	1,4 km/h	7800 kg	47 kN	3,35 kN/m ²	3,94 kN/m ²

Available power options:

BI-ENERGY (DIESEL+AC)

ECO (AC+BATTERY)

HYBRID (DIESEL+AC+BATTERY)

Characteristics and technical data are informative only and subjected to change without notice.

Palazzani Industrie S.p.A.

Via del Pavione, 4 - 25050 - Paderno F.C. (BS) - Italy

Tel. (+39) 0306857073



info@palazzani.it

www.palazzani.it





HYBRID²

-  Diesel
14,7 kW
-  Single-phase Electric motor
230VAC - 16 kW
-  Lithium iron phosphate battery
LiFePO4
48V - 315 Ah

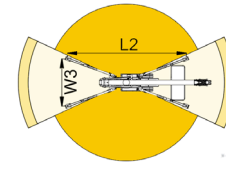
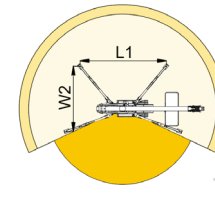
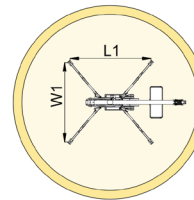
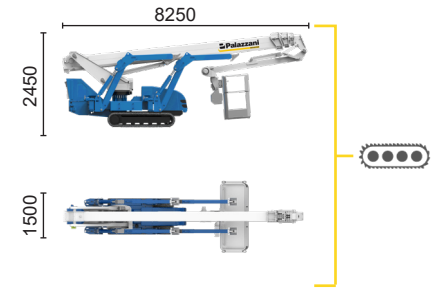
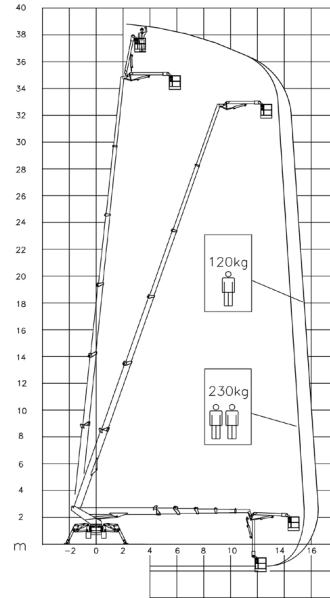
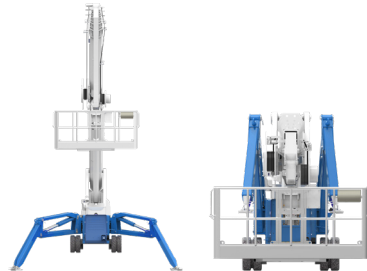



15,5 m	16,5 m	10 m	L1	L2	W1	W2	W3
230 kg	120 kg	230/120 kg	4960 mm	6200 mm	4700 mm	3810 mm	2610 mm



TSJ 39/C  39 m 16,5 m 230 kg 660° 240x70 cm 90°+80° 2,92-4,7 m 18% 40% 2,2 km/h 8100 kg 47 kN 3,47 kN/m² 4,09 kN/m²

Available power options:

-  **BI-ENERGY** (DIESEL+AC)
-  **ECO** (AC+BATTERY)
-  **HYBRID²** (DIESEL+AC+BATTERY)

Characteristics and technical data are informative only and subjected to change without notice.

Palazzani Industrie S.p.A.
Via del Pavione, 4 - 25050 - Paderno F.C. (BS) - Italy
Tel. (+39) 0306857073
info@palazzani.it
www.palazzani.it



NC 816 A 22