











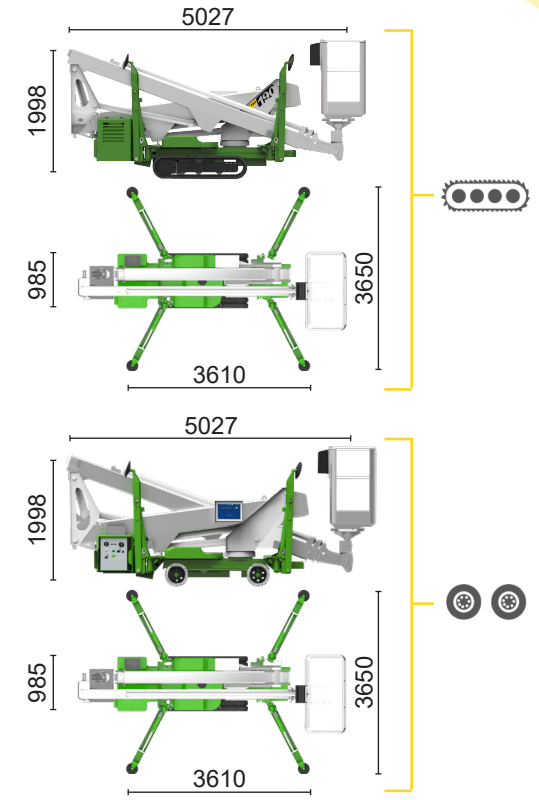
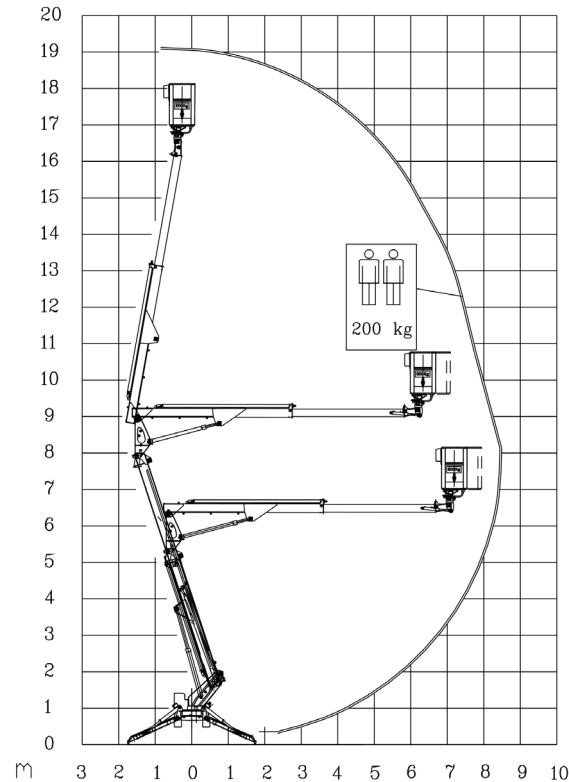









ECO

 Inverter actuated
Electric motor
9 kW

 Lithium iron
phosphate battery
LiFePO4 - 10,8 kWh
(48 V - 210 Ah)



																
TZX 190/C		19 m	8,5 m	200 kg	360°	140x70 cm	90°+90°	3,65 m	21%	23%	2,4 km/h	2300 kg	16 kN	1,75 kN/m ²	3,27 kN/m ²	
TZX 190/R		19 m	8,5 m	200 kg	360°	140x70 cm	90°+90°	3,65 m	21%	21%	1 km/h	2400 kg	16 kN	1,82 kN/m ²	3,41 kN/m ²	

Available power options:

BI-ENERGY (DIESEL+AC)

The technical data may deviate +/- 3% from the specified values.

Characteristics and technical data are informative only and subjected to change without notice.

Palazzani Industrie S.p.A.

Via del Pavione, 4 - 25050 - Paderno F.C. (BS) - Italy

Tel. (+39) 0306857073

info@palazzani.it

www.palazzani.it



NC 959 A 24